



Garden valve with vacuum valve and key

Our garden valves are self-draining and therefore frost-proof even if you forget to dismantle the garden hose before the season with degrees below zero. However, we recommended that you always remove the hose and coupling when there is a risk of low temperatures.

Article number: 42940400

Description: For wall thickness max. 400 mm

Unique characteristics

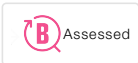

Backflow protection unit type 

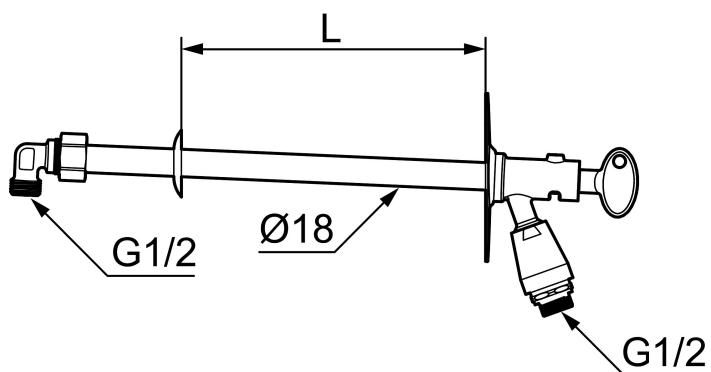

- Self-draining
- With vacuum valve and key
- With approved non-return valve
- Frost-proof even if the hose/coupling is connected
- Can be cut to suit wall thickness
- Wall bracket: H=106 mm, W=66 mm, diagonal screw holes
- Approved backflow prevention device, EN-Standard EN 1717